



ChargePoint® Home

Installation Guide



ATTENTION: Please read thoroughly and keep this installation guide.

Contents

Meet ChargePoint Home	3
Setup and Installation	4
For Professional Electricians	9
Safety	11
Limited Warranty	12
Terminology	14
Status Light Key	15

Meet ChargePoint Home

→ For information on Hardwire and outlet installation by professional electricians, refer to pages 9-10.

Inside the boxes you'll find...

Charging Station Box:

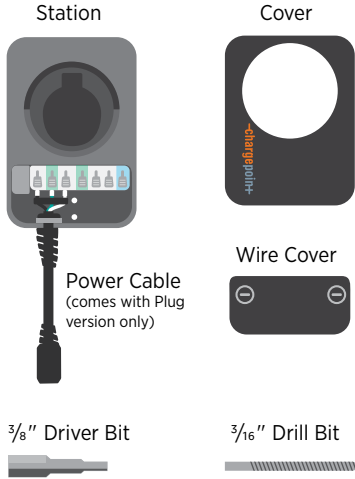

Installation Template

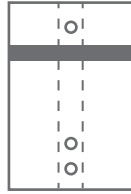

(3) 2 X $\frac{1}{4}$ " Lag Screws

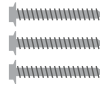

Charging Cord Box:

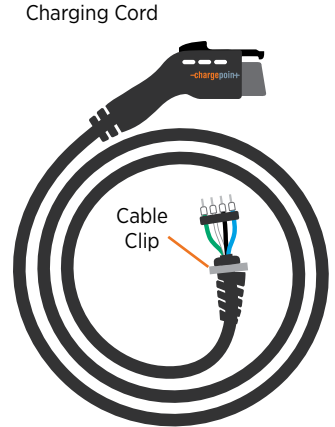

If you're missing any of these parts, please call 1.888.758.4389

Items needed:

For Plug version:
NEMA 6-20 or 6-50 240V outlet,
installed ground facing up



Tape



Pencil



Stud Finder



Level



Drill



Coin



Requirements to activate the Home station:

- + WiFi and Bluetooth
- + iOS or Android Phone
- + ChargePoint mobile app (free)
- + ChargePoint account (free)

Activation of Home will allow you to schedule charging, start sessions remotely and set reminders so you never forget to charge. You'll be able to view and track all your residential, public and workplace charging in one place including energy usage and how many miles you've added during a charging session based on your car model. You'll also be able to update your station remotely with any software upgrades. Plus, Home works with Nest to help you save on energy costs.

Setup and Installation

1 Watch the Installation Video

Download the ChargePoint app from the Apple App Store™ or Google Play™, select **Home Charger** from the main menu and watch the Home Installation Video.



→ For Plug version, start at Step 2. For Hardwire and outlet installation, refer to the steps for professional electricians on pages 9-10.

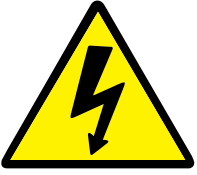

DANGER: RISK OF SHOCK

Turn off circuit breaker to 240V outlet. Do not restore power to the outlet until installation is complete. Failure to follow these instructions could result in shock or electrocution.

2 Find a wall stud

- + Find the center of the nearest stud to the installed outlet using a stud finder
- + Mark the center of the stud with a line

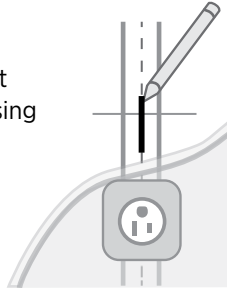

Tip (Plug version only): To find the station's ideal mounting height, plug the station's power cord into the outlet.

3 Choose station installation location (Plug version only)

- + If you haven't already, turn off your circuit breaker
- + Plug the station in. **WARNING:** If the front status light turns on when the station is plugged in, your circuit is not off. STOP IMMEDIATELY. Unplug the station and turn off the power to the outlet at the circuit breaker.
- + Place the station against the wall, line up the station's two mounting holes with the line you marked earlier
- + Mark the two lower mounting holes
- + Unplug the station

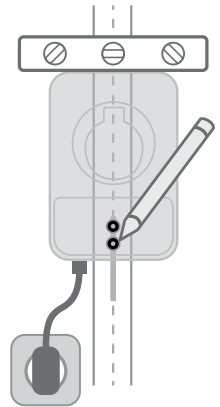
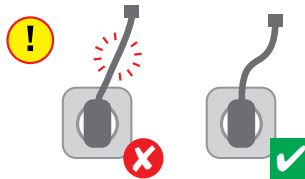

Tip: Be sure the power cord has a gentle curve but is not stretched.

Steps 4-13 apply to both Plug and Hardwire versions.

4 Mount the station

- + Line up the lower mounting holes with the marks you made and tape the installation template against the wall
- + Mark the top mounting hole on the wall with the installation template
- + Remove the template
- + Drill the three mounting holes with the included drill bit. **WARNING:** If you hit metal, stop immediately and contact an electrician

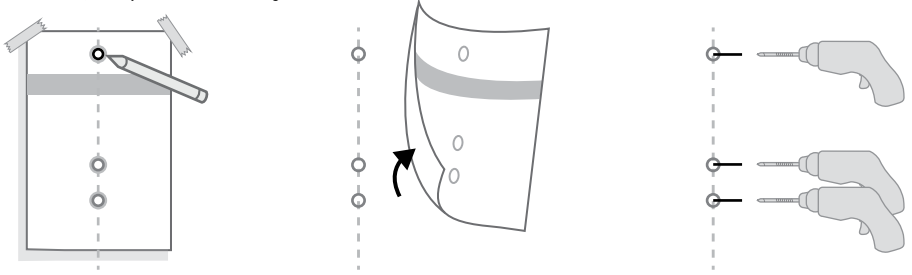

5 Install top mounting screw

- + Use the driver bit to drive a screw into the top-most mounting hole, leaving a 1/8" gap to hang the station on
- + Keep the remaining 2 screws for use later

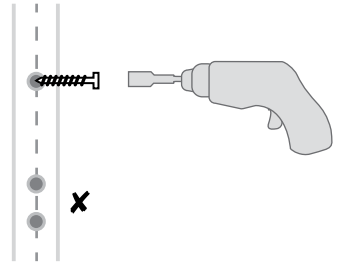

6 Hang the station

- + Hang the station on the protruding screw using the notch on the back of the station
- + **Don't plug in yet**
- + Drive the remaining 2 screws into the bottom mounting holes to secure the station. Be careful not to damage the electrical wires

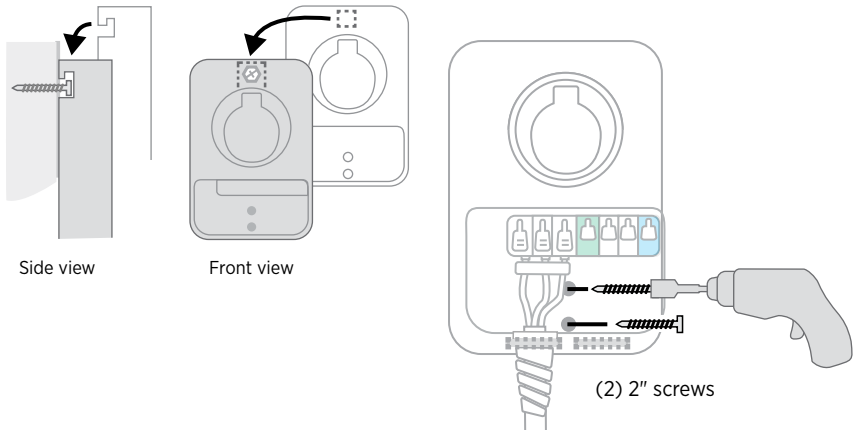

7 Remove the cable clip

Remove the cable clip from the wire end of the cord, but do not discard it.

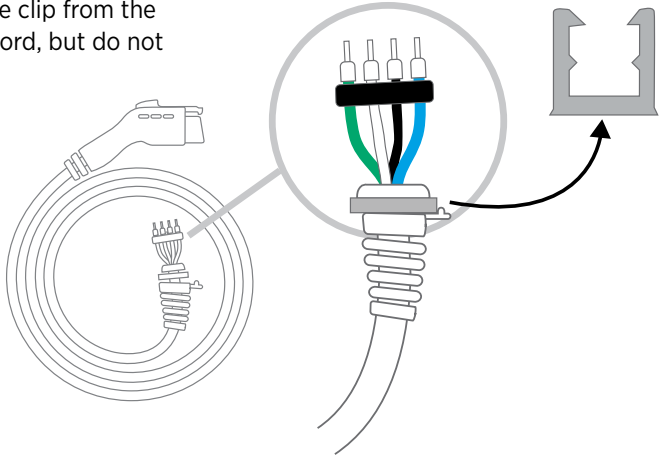

8 Connect the charging cord

- + Fold the wire ends and insert them into the bottom hole of the station
- + Match the blue and green wires to the blue and green connector blocks
- + Insert the exposed wires into the corresponding holes, pushing the cables up until the silver conductors are no longer visible
- + Snap down the white clips all the way down on each wire

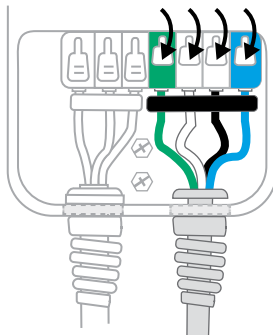
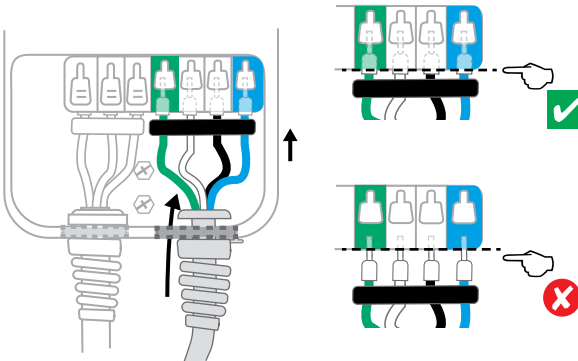
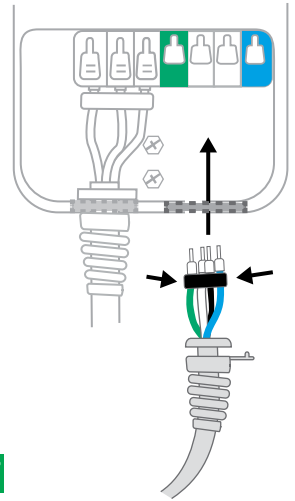

Tip: Keep fingers away from underneath the white clips as you snap them down.

9 Attach the cable clip

Push the cord up and slide the cable clip into the slot to secure the cord.

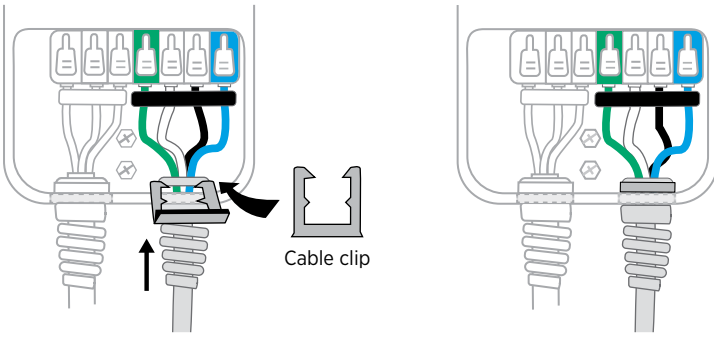

Tip: The cable clip protects the cord from damage

10 Lock the wire cover in place

- + Place the wire cover over the exposed wiring
- + Using a coin, lock the cover in place

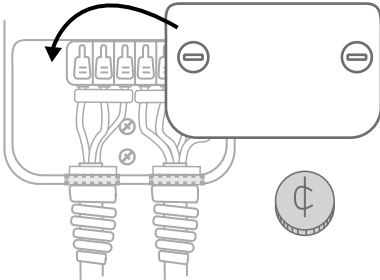

Tip: To avoid damage, do not use a screwdriver

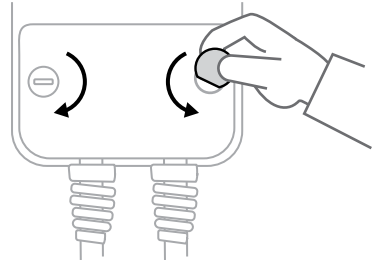

11 Snap the cover on the station

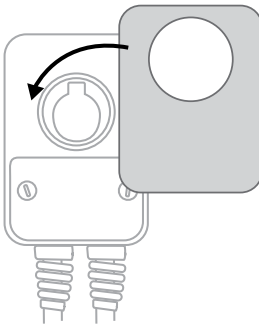

12 Turn on your station

- + Wrap the charging cord around the top of the station and dock the connector
- + Plug the station into the outlet (Plug version)
- + Restore power to the outlet (Plug version) or restore power to the station (Hardwire)

Tip: Once power is restored, the front status light will glow yellow, then white. When it is white, proceed to Step 13.

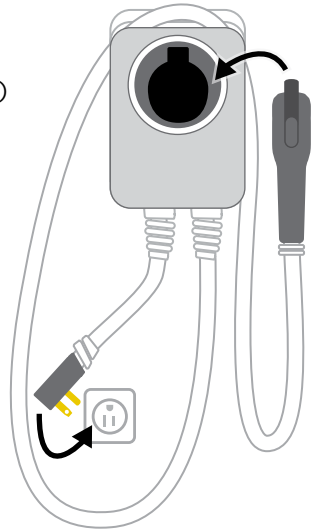

13 Activate your station

- + Turn on Bluetooth and WiFi on your mobile
- + Open the ChargePoint app. On the main menu click **Home Charger**
- + Select “Set Up Home Charger”
- + Select “Activate” and follow the instructions

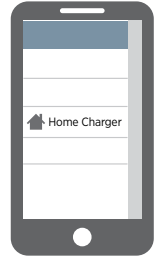

Activation of Home will allow you to schedule charging, start sessions remotely and set reminders so you never forget to charge. You'll be able to view and track all your residential, public and workplace charging in one place including energy usage and how many miles you've added during a charging session based on your car model. You'll also be able to update your station remotely with any software upgrades. Plus, Home works with Nest to help you save on energy costs.

Congratulations, you're ready to charge.

Drive happier.



For Professional Electricians

Tips to install electrical service for ChargePoint Home

→ Start Here for Plug Installation

ChargePoint Home 12: 16A Station

- + 240V, 20A dedicated circuit required.
- + NEMA 6-20 outlet installed ground pin on top.

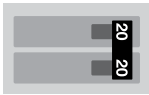

Tip: Requires a new, dedicated, non-GFCI two-pole circuit breaker

ChargePoint Home 25: 32A Station

- + 240V, 40A dedicated circuit required.
- + NEMA 6-50 outlet installed ground pin on top.



Tip: Requires a new, dedicated, non-GFCI two-pole circuit breaker

The NEMA outlet should be located 20-26" from the ground. Refer to the installation template to decide where to install the station.

The power cord will not bend and is only 12" long (as per the National Electric Code for EV chargers), so ensure the outlet is installed close enough for the power cord to plug in.

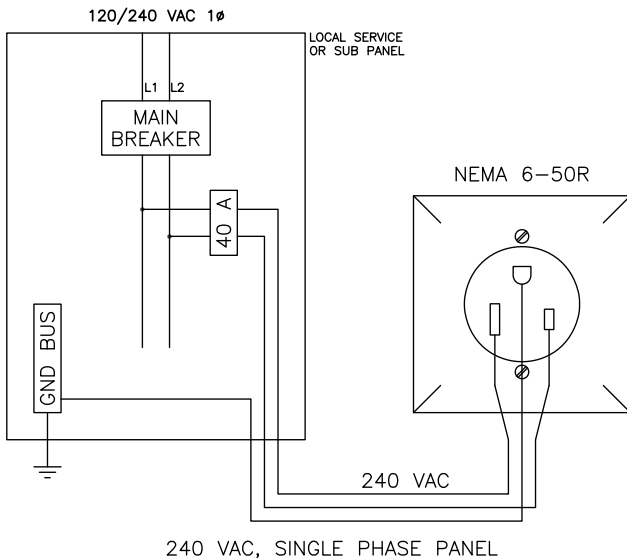
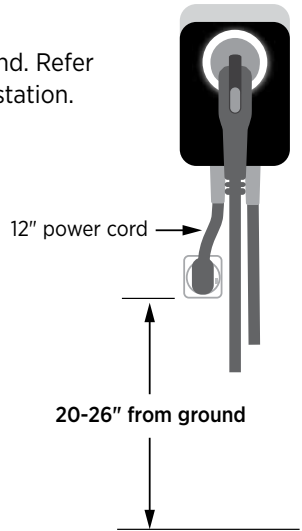

- Neutral is not required at the outlet
- Install outlet with ground pin on top

→ Start Here for Hardwire Installation

ChargePoint Home 12: 16A Station
240V, 20A dedicated circuit required

ChargePoint Home 25: 32A Station
240V, 40A dedicated circuit required

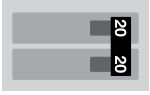

Tip: Requires a new, dedicated, non-GFCI two-pole circuit breaker



Tip: Requires a new, dedicated, non-GFCI two-pole circuit breaker

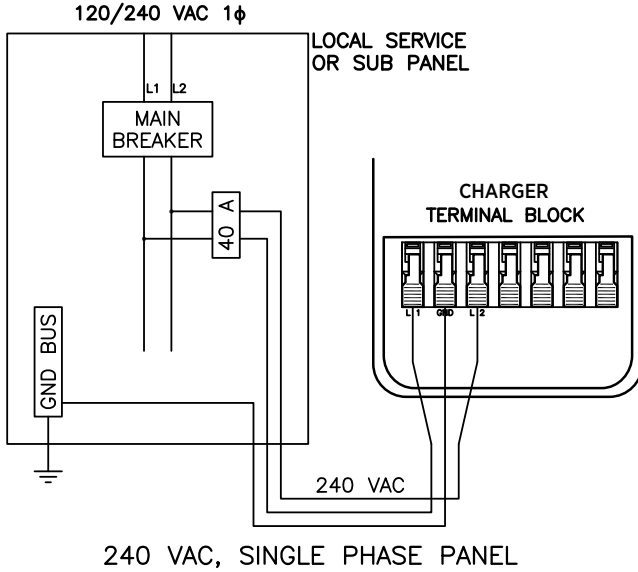

- Use $\frac{3}{4}$ " conduit
- Use appropriate fittings for connection
- Strip wire ends to $\frac{1}{2}$ "
- Insert wires fully into charger terminal block

→ For Both Hardwire and Plug

Ensure the homeowner has chosen an installation location that allows the charging cord to reach the car's charging port while still providing slack.

Charging cord reaches car without any tautness

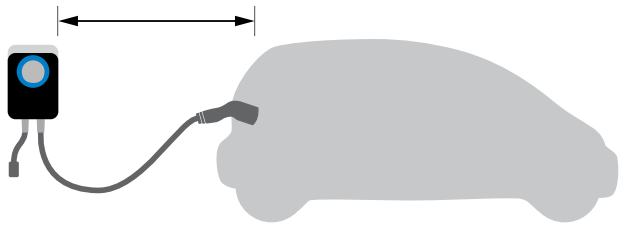

→ Next Steps

Go to **Step 4** on page 5 for station mounting instructions.

Questions?

☎ Call U.S. and Canada toll-free: +1.888.758.4389 (24 hours)

@ Email support@chargepoint.com

Safety

IMPORTANT SAFETY INSTRUCTIONS

SAVE THESE INSTRUCTIONS

INSTRUCTIONS PERTAINING TO A RISK OF FIRE OR ELECTRIC SHOCK:

WARNING: When using electric products, basic precautions should always be taken, including the following. This manual contains instructions that shall be followed during installation, operation and maintenance of the unit.

For permanently connected (hardwired) charging stations, ChargePoint Home must be installed by a qualified electrician and in accordance with all local electrical codes and ordinances.

Read all instructions before installing and using Home. All documents can also be found online at chargepoint.com/home.

Adult supervision is required when using Home near children.

Do not operate your Home if there is visible damage to the unit or charging cord. Call ChargePoint customer support immediately at 1.888.758.4389.

Do not put fingers into the charging connector.

Do not install Home near flammable, explosive, or combustible materials.

Do not operate Home in temperatures outside its operating range of -22°F to 122°F (-30°C to 50°C).

Other than the charging cord, Home contains no user serviceable parts. Do not attempt to repair or service any other part of the unit yourself. If the unit requires servicing, contact ChargePoint, Inc.

Ensure that the Home charging cord is positioned so it will not be stepped on, tripped over, or subjected to damage or stress. Do not close a garage door on the charging cord.



Symbol for Risk of Shock

WARNING FOR CHARGEPOINT HOME PLUG PRODUCTS:

GROUNDING INSTRUCTIONS

Home must be grounded. If it should malfunction or break down, grounding provides a path of least resistance for electric current to reduce the risk of electric shock. This product is equipped with a cord having an equipment grounding conductor and a grounding plug. The plug must be plugged into an appropriate receptacle that is properly installed and grounded in accordance with all local codes and ordinances.

WARNING: Improper connection of the equipment-grounding conductor may result in a risk of electric shock. Check with a qualified electrician or serviceperson if you are in doubt as to whether the product is properly grounded. Do not modify the plug provided with the product—if it will not fit the receptacle have a proper receptacle installed by a qualified electrician.

WARNING FOR CHARGEPOINT HOME HARDWIRE (PERMANENTLY CONNECTED) PRODUCTS:

GROUNDING INSTRUCTIONS

This product must be connected to a grounded, metal, permanent wiring system, or an equipment-grounding conductor must be run with the circuit conductors and connected to the equipment grounding terminal or lead on the product. See Installation Instructions.



UL Listed to U.S. and Canadian safety standards
NEC Article 625 compliant

Limited Warranty

Limited Warranty for ChargePoint Home Electric Vehicle Charging Station

Our Promise

This Limited Warranty for ChargePoint Home Electric Vehicle Charging Station (“Warranty”) applies to you, the original purchaser of a new CHARGEPOINT HOME Charging Station (the “Charging Station”) from CHARGEPOINT solely for use by you at your residence. This warranty is not transferrable and is valid for purchasers located in the U.S.A. and Canada only.

LIMITED THREE-YEAR PARTS EXCHANGE WARRANTY: Subject to the exclusions from Warranty coverage set forth below, CHARGEPOINT warrants that, when used under normal operating conditions, your Charging Station will be free from any defects in materials or workmanship for a period (the “Warranty Period”) of three (3) years from the date of original purchase. If, during the Warranty Period, your Charging Station becomes defective in breach of the Warranty, CHARGEPOINT will, upon written notice of the defect received during the Warranty Period, either repair or replace, at CHARGEPOINT’s election, the Charging Station. The Warranty covers both parts and factory labor necessary to repair your Charging Station, but does not include any on-site labor costs related to un-installing or reinstalling the repaired or replacement Charging Station.

Follow These Easy Steps to Obtain Warranty Service

1. If at any time during the term of your Warranty you believe you have a defective Charging Station, contact Customer Service at 1.888.758.4389 or support@chargepoint.com and request a Return Material Authorization (“RMA”) number from ChargePoint.
2. In connection with your RMA request, you will be asked for each of the following:
 - a. A detailed description of the problems you are experiencing with the Charging Station;
 - b. The model number and serial number of the Charging Station;
 - c. Proof of purchase; and
 - d. Shipping information.
3. If ChargePoint determines that the defect appears to be covered by your Warranty and your Warranty is still in effect you will be provided a Returned Material Authorization number (RMA number) to reference when returning the defective Charging Station for repair or replacement.
4. Ship the defective Charging Station to CHARGEPOINT and reference the RMA number in the shipping documentation. The Charging Station must be returned in its original shipping container or in another shipping container designed to prevent damage to the Charging Station.
5. If your Charging Station is covered by your Warranty, CHARGEPOINT will either repair or replace the defective Charging Station at no charge to you and ship the repaired or replaced Charging Station back to you at CHARGEPOINT’s expense.

Important

1. You are responsible for the proper installation and maintenance of the Charging Station including the un-installing of any defective Charging Station and the installation of the repaired or replacement Charging Station returned to you.
2. Any service or repairs beyond the scope of the Warranty above will be performed upon customer approval at CHARGEPOINT’s then prevailing labor rates and other applicable charges.
3. Any Charging Station that is found by CHARGEPOINT to be out-of-warranty or otherwise ineligible for warranty service will be returned, repaired or replaced upon your approval at CHARGEPOINT’s standard charges at your expense.
4. Please read carefully through the detailed descriptions of the WARRANTY, the EXCLUSIONS FROM LIMITED PRODUCT WARRANTY, and the LIMITATIONS ON WARRANTY AND LIABILITY on the following pages to assure that your Charging Station is eligible for warranty service without additional cost to you.

Replacement Parts Or Charging Stations

You acknowledge that replacement parts or Charging Stations provided by CHARGEPOINT under the Warranty may be remanufactured or reconditioned parts or Charging Stations or, if the exact Charging Station is no longer manufactured by CHARGEPOINT, a Charging Station with substantially similar functionality (“Replacement Products”). All replaced parts, whether under warranty or not, become the property of CHARGEPOINT.

Any replacement parts or Charging Station so furnished will be warranted for the remainder of the original Warranty Period or ninety days from the date of delivery of such replacement parts or Charging Station, whichever is later. Should CHARGEPOINT be unable to repair or replace your Charging Station, CHARGEPOINT will refund the purchase price of the Charging Station to you.

Exclusions from Limited Product Warranty

IMPORTANT: The Warranty on your Charging Stations shall not apply to defects or service repairs resulting from the following:

- Improper site preparation or maintenance, improper installation, cosmetic damage such as scratches and dents, or normal aging.
 - Abuse, vandalism, damage or other problems caused by accidents, misuse or negligence (including but not limited to physical damage from being struck by a vehicle), or use of the Charging Station in a way other than as specified in the applicable CHARGEPOINT documentation.
 - Damage to the Charging Station caused by software, interfacing, parts, supplies or any other product not supplied by CHARGEPOINT.
 - Damage as a result of extreme power surge, extreme electromagnetic field or any acts of nature.
- Any other causes beyond the control of CHARGEPOINT.

IN ADDITION: The Warranty on your Charging Station shall not apply if the original identification markings (for example, serial numbers and trademarks) have been defaced, altered or removed or if the Charging Station is used or installed for any purpose other than for use at a single family residence.

CHARGEPOINT SPECIFICALLY DOES NOT WARRANT THAT ANY CHARGEPOINT SERVICES WILL BE ERROR FREE OR WILL OPERATE WITHOUT INTERRUPTION.

Limitations on Warranty and Liability

NO AGENT OF CHARGEPOINT IS AUTHORIZED TO ALTER OR EXCEED THE WARRANTY OBLIGATIONS OF CHARGEPOINT. THE REMEDIES IN THIS LIMITED PRODUCT WARRANTY ARE YOUR SOLE AND EXCLUSIVE REMEDIES. CHARGEPOINT MAKES NO OTHER EXPRESS OR IMPLIED WARRANTIES OTHER THAN THE WARRANTY SET FORTH ABOVE. ALL OTHER WARRANTIES, INCLUDING WITHOUT LIMITATION ANY WARRANTY OF DESIGN, MERCHANTABILITY, FITNESS FOR A PARTICULAR PURPOSE (EVEN IF CHARGEPOINT HAS BEEN INFORMED OF SUCH PURPOSE) OR AGAINST INFRINGEMENT, ARE EXCLUDED TO THE EXTENT PERMITTED BY LAW. IF ANY IMPLIED WARRANTY CANNOT BE DISCLAIMED UNDER APPLICABLE LAW, SUCH IMPLIED WARRANTY SHALL BE LIMITED IN DURATION TO THE WARRANTY PERIOD DESCRIBED ABOVE. NO WARRANTIES APPLY AFTER EXPIRATION OF THE WARRANTY PERIOD.

Some states or jurisdictions do not allow the exclusion of express or implied warranties or limitations on how long an implied warranty lasts, so the above limitation may not apply to you.

CHARGEPOINT IS NOT LIABLE FOR ANY INDIRECT, INCIDENTAL, SPECIAL, PUNITIVE OR CONSEQUENTIAL DAMAGES, INCLUDING WITHOUT LIMITATION LOST PROFITS, LOST BUSINESS, LOST DATA, LOSS OF USE, OR COST OF COVER INCURRED BY YOU ARISING OUT OF OR RELATED TO YOUR PURCHASE OR USE OF, OR INABILITY TO USE, THE CHARGING STATION, UNDER ANY THEORY OF LIABILITY, WHETHER IN AN ACTION IN CONTRACT, STRICT LIABILITY, TORT (INCLUDING NEGLIGENCE) OR OTHER LEGAL OR EQUITABLE THEORY, EVEN IF CHARGEPOINT KNEW OR SHOULD HAVE KNOWN OF THE POSSIBILITY OF SUCH DAMAGES. IN ANY EVENT, THE CUMULATIVE LIABILITY OF CHARGEPOINT FOR ALL CLAIMS WHATSOEVER RELATED TO THE CHARGING STATION WILL NOT EXCEED THE PRICE YOU PAID FOR THE CHARGING STATION. THE LIMITATIONS SET FORTH HEREIN ARE INTENDED TO LIMIT THE LIABILITY OF CHARGEPOINT AND SHALL APPLY NOTWITHSTANDING ANY FAILURE OF ESSENTIAL PURPOSE OF ANY LIMITED REMEDY.

Some states or jurisdictions do not allow the exclusion or limitation of incidental or consequential damages, so the above limitation or exclusion may not apply to you.

Additional Information

This Warranty shall be governed by and construed in accordance with the laws of the State of California, U.S.A., exclusive of its conflict of laws principles. The U.N. Convention on Contracts for the International Sale of Goods shall not apply.

This Warranty is the entire and exclusive agreement between you and CHARGEPOINT with respect to its subject matter, and any modification or waiver of any provision of this statement is not effective unless expressly set forth in writing by an authorized representative of CHARGEPOINT.

Terminology

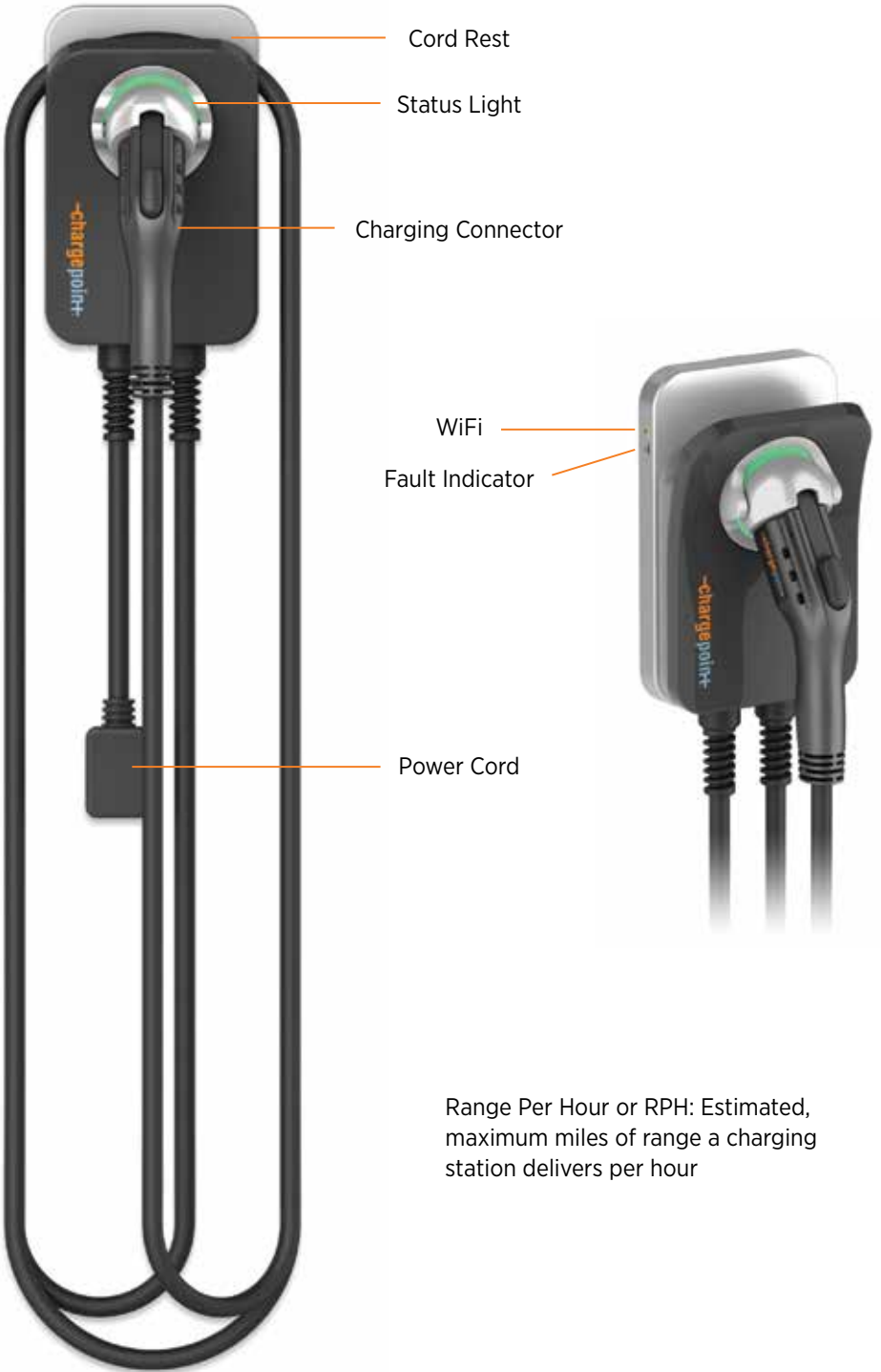

Range Per Hour or RPH: Estimated, maximum miles of range a charging station delivers per hour

ChargePoint® Home

Status Light Key

Not Connected to Internet

Ready to charge



White

Charging



Pulsing blue

Fault



Red

Connected to Internet

Ready to charge



Green

Schedule set



Pulsing green

Plugged in



Blue

Charging



Pulsing blue

Fault



Red

Tip: To override a set schedule and start charging immediately—



1. Make sure the connector is plugged into the car

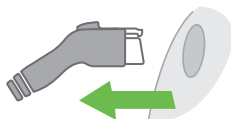

2. Remove the connector from the car

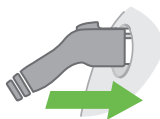

3. Plug back in within 7 seconds

Questions?

Visit chargepoint.com/home or call 1.888.758.4389

Need Help?



1.888.758.4389

Call us any time, any day
or email us at support@chargepoint.com

We want to hear from you.

Take a minute to review Home on Amazon or drop us a line on Twitter or Facebook.



[@chargepointnet](https://twitter.com/chargepointnet)



[ChargePoint](https://www.facebook.com/ChargePoint)



ChargePoint, Inc.
254 E Hacienda Avenue, Campbell, CA | 95008-6617 USA
US toll free +1.888.758.4389
chargepoint.com

Copyright © 2015 ChargePoint, Inc. All rights reserved. CHARGEPOINT is a U.S. registered trademark/service mark, and an EU registered logo mark of ChargePoint, Inc. All other products or services mentioned are the trademarks, service marks, registered trademarks or registered service marks of their respective owners. IG-Home-01. October 2015 75-001145-02-3.

Printed on paper made with 10% post consumer waste.